



345 Bayview Avenue, Amityville, New York 11701  
 For Sales and Repairs 1-800-ALALOCK  
 For Technical Service 1-800-845-9440  
 or visit us at <http://tech.napccosecurity.com/>

(Note: Technical Service is for security professionals only)  
 Publicly traded on NASDAQ Symbol: NSSC

© ALARM LOCK 2017

# Trilogy T2

## Programming Instructions

### For DL2700 Mortise, Cylindrical & Exit Trim Locks

OI209B 2/17

### CONGRATULATIONS!

Your new Alarm Lock Trilogy electronic digital lock is a rugged entry lock of advanced design with several programmable features. Three "maintenance levels" are provided: **Master** (can perform ALL functions), **Manager** (can perform MOST functions plus entry), and **Basic User** (entry only).



DL2700  
(Cylindrical)

The lock includes 100 User Codes (consisting of Managers and Basic Users), plus three "one-time entry" Service Codes. The Manager/Basic User Codes are organized similar to a grid--ten banks of ten Access Codes.

Take the time to read through this guide to familiarize yourself with the features and operations of the lock, and its quick and easy programming procedures.

### Features

- 1 Master Code (all functions including entry)
- 10 Manager Codes (perform SOME programming functions plus entry)
- 90 Basic User Access Codes (Entry Only)
- 3 Service Codes ("One-Time Entry" Codes)
- Two User Disable Modes:
  - All User Codes Disabled Except Master Code
  - All User Codes in a Bank Disabled Except Manager Codes
- 30-Second Keypad Anti-Tamper Lockout: (Keypad Lockout After 3 Unsuccessful User Code Entries)
- Programmable Relay Functions: (Relay may be keypad programmed to energize on any keypress 0-9 or on unlock).

### QUICK LOOKUP

|  |          |
|--|----------|
| Wiring .....   | 2        |
| <b>Quick Start</b> .....                               | <b>2</b> |
| Testing Codes .....                                    | 3        |
| Manager & User Location Worksheet .....                | 4        |
| Manager & User Location Example .....                  | 5        |
| Programming Worksheet: Functions.....                  | 6        |
| Change Existing Master Code.....                       | 7        |
| Add/Change Manager Codes.....                          | 7        |
| Add/Change User Codes .....                            | 7        |
| Deleting Codes.....                                    | 7        |
| Disable/Enable Users.....                              | 7        |
| Disable/Enable All.....                                | 8        |
| Code Location Function .....                           | 8        |
| Next Free Code Address Locator.....                    | 8        |
| Add/Delete Service Codes .....                         | 9        |
| Enable/Disable Passage Mode .....                      | 9        |
| Pass Time ("Door Unlock").....                         | 9        |
| Disable/Enable Groups .....                            | 9        |
| Disable/Enable Users in Bank.....                      | 10       |
| Keypress Sound Options .....                           | 10       |
| AUX Relay Functions .....                              | 10       |
| Lock Identifier.....                                   | 10       |
| Enable / Disable Emergency Chirp .....                 | 11       |
| Remote Switch Input Wires Toggle<br>Passage Mode ..... | 11       |
| Audible and LED Indications.....                       | 12       |
| Battery Replacement .....                              | 12       |
| Erase All Programming.....                             | 12       |
| Extra Manager & User Location Worksheets .....         | 13-15    |
| Limited Warranty .....                                 | 16       |

# Wiring

See the Installation Instructions for more information.

## Batteries:

Use only 1.5 volt Duracell Alkaline size-AA batteries.

## External Power:

An external 7.5 VDC Power Source, capable of at least 100mA, must be used for operation without batteries in the lock. Use an external UL-Listed power supply provided with backup battery power and current limiting protection that is approved for the application.

BLACK = Negative, RED = Positive.

## Aux Relay:

Aux Relay allows up to 300mA @ 60VDC Maximum. See page 10 for programming options for the Relay ("AUX Relay Functions").



BLUE = Common, YELLOW = N/O, GREEN = N/C.

## Remote Switch Input (2 White Wires)

A remote momentary switch can be wired to allow access when activated. Wire a normally open push button switch to the two white wires. Press for one second to unlock the unit.

# Quick Start

## First Time Start Up









1. Unpack the lock from its factory packaging.
2. With the batteries disconnected, hold down the  key (or any numeric key) for 10 seconds and release.
3. Connect the batteries and--within 3 seconds--press and hold the  button. After hearing 6 beeps, release the  button. Wait 5 seconds for lock to re-lock (listen for 1 beep and red LED). This will clear the lock of all programmed data, and the lock is now ready to accept programming. **Note:** Failure to follow this exact procedure can result in erratic lock behavior.

**Important Note:** When entering any key sequence below, *do not pause more than 5 seconds between any key presses*--otherwise you must start again. (**Note:** If you wish, this 5-second delay between key presses can be extended--see *Pass Time* on page 9 after completing this section).

*No other programming commands will be accepted until the Factory Master Code has been changed.*

## Change Factory Master Code

The Master Code is a "secret" code (entered at the keypad) that allows you to change ALL programming functions and options. Because all locks are manufactured identically (and leave the factory with the *same* Master Code), this "factory Master Code" is not very secret--and **MUST** be changed to your own personal Master Code to ensure security. A 5-6 digit Code is recommended.

1. Press the factory Master Code:     . A beep will sound and the lock will open.
2. Within 5 seconds, press   .
3. Within 5 seconds, enter a new Master Code. This new Master Code may consist of 3 to 6 digits\*, however, the number selected determines the number required for all subsequent Manager and User Access Codes.
4. Press .
5. Re-enter the new Master Code again to validate. A 6-beep acknowledgement (with a red LED) will sound. Wait 5 seconds for lock to re-lock.
6. Test the new Master Code. Enter the new Master Code; a beep will sound and the lock will unlock. Now that the Master Code has been changed, there is no need to change it again (unless you want to).

For example, if you want your new Master Code to be "44444", press:

If you wish, write your new Master Code in the spaces provided:

        \_\_\_\_\_  \_\_\_\_\_

Write your new Master Code

(Repeat)

*Continued*

\* Once the number of digits is selected, it cannot be changed unless all programming is erased and the Factory Default settings are re-loaded using the "Erase All Programming" procedure found on page 12.

## Quick Start (cont'd)

### Enter a Manager Code

Manager Codes are located at locations 00, 10, 20, 30, 40, 50, 60, 70, 80, and 90 (see grid on page 4). **Note:** New Manager Codes MUST use the same number of digits as the (new) Master Code. Enter as follows.

1. Press the (new) Master Code.
2. Press [press a Manager location i.e. 00, 10, 20, 30, 40, 50, 60, 70, 80, or 90] .
3. Press a new Manager Code using the same number of digits as the (new) Master Code. A 6-beep acknowledgement (with a red LED) will sound. Wait 5 seconds for lock to re-lock.  
For example, if you want to add a Manager Code of "33333" in location 00,  
[Press the (new) Master Code] .
4. If lock remains open, repeat from step 2; otherwise restart from step 1 for each new Manager Code.

### Enter Basic User Access Codes

See the grid on page 4 for more information regarding User locations. You can choose to enter your User Codes in many possible locations, and in any order you wish. User Codes do not have programming privileges (entry only). Duplicate User Codes are not allowed.

1. Press the (new) Master Code or associated Manager Code.
2. Press [press a 2-digit location number] .
3. Press a new User Access Code using the same number of digits as the (new) Master Code. A six-beep acknowledgement (with a red LED) will sound. Wait 5 seconds for lock to re-lock. The new User Access Code is now entered in that location number.  
For example, if you want to add a User Access Code of "22222" in User Number 01, press:  
[(New) Master Code] .
4. If lock remains open, repeat from step 2; otherwise restart from step 1 for each new User Access Code.

### Delete a User Access Code

The Master Code cannot be deleted. Manager Codes can only be deleted with the Master Code. If the location (User Number) of the Code is unknown, use the Code Location Function (page 8).

1. Press the (new) Master Code or Manager Code.
2. Press [press the 2-digit location number] . A six-beep acknowledgement (with a red LED) will sound. Wait 5 seconds for lock to re-lock. The User Access Code is now deleted.  
For example, if you want to delete a User Access Code located in location 47, press:  
[(New) Master/Manager Code] .
3. If lock remains open, repeat from step 2; otherwise restart from step 1 for each User Access Code you want to delete.

## Testing Codes

**VALID CODE** - The Green LED will flash (with 1 beep) after a valid code is entered. The lock will unlock immediately and remain unlocked for about 5 seconds (this "unlocked" time is the "Pass Time"). To make the Pass Time longer or shorter, use the Pass Time Function on page 9. **Note:** While the lever or knob may be rotated at any time, the latch will not be engaged to unlock the door unless a valid User Access Code is entered at the keypad.

**INVALID CODE** - The Red LED will flash 5 times (with 5 beeps) after an invalid code is entered. (To quickly clear an invalid User Access Code, press and immediately re-enter the correct Code).

**KEYPAD ANTI-TAMPER LOCKOUT** - If 3 invalid User Access Codes are entered in succession, the lock will turn off for approximately 30 seconds to prevent tampering. The lock will emit 2 beeps with a Red LED flash warning at the end of the anti-tamper period. The lock will exit Anti-Tamper mode in 30 seconds or upon activation of the Remote Switch Input (white wires). **Note:** The lock will go into Anti-Tamper after 3 unsuccessful Code entries *even if entered by different users and spaced apart in time*. Therefore, the lock may "appear" to go into Anti-Tamper Lockout *even after the entry of just one invalid User Access Code*.

# Manager & User Location Worksheet

The lock provides three "maintenance levels": **Master** (can perform ALL functions), **Manager** (can perform SOME programming functions plus entry), and **Basic User** (entry only). In total, there are 104 "locations" inside the lock: one Master Code, 10 Manager and 90 User Access Codes, and three "one-time entry" Service Codes. *Where the Access Code is located will determine its "maintenance level"*. From the factory, all locations (except for the Master Code) are empty; each location can then be programmed to contain an Access Code, and these Access Codes enable Users to program and/or unlock the lock. As a visual aid, the 100 Manager/User Access Code locations are detailed in the grid below, with ten "Banks" (columns) of ten "Managers/Users" (rows). Each of the 100 squares in the grid is identified by a unique two-digit location (00) through (99). Notice that these two digits also specify its Bank (column) and Manager/User (row) location in the grid. Also notice that all Managers are in the top row, their locations all ending in a zero (locations 00, 10, 20, 30 and so on through 90). **Note:** Use the blank grid below as a **Programming Worksheet** for preparing all programming in advance. Store this worksheet in a safe place for future reference.

Each square represents a location inside the lock (excluding the Master Code and the 3 Service Codes). Each location can hold one "User Access Code" which can unlock the lock.

|                      | BANK 0           | BANK 1           | BANK 2           | BANK 3           | BANK 4           | BANK 5           | BANK 6           | BANK 7           | BANK 8           | BANK 9           |
|----------------------|------------------|------------------|------------------|------------------|------------------|------------------|------------------|------------------|------------------|------------------|
| <b>MANAGERS</b><br>→ | MGR 00<br>-----  | MGR 10<br>-----  | MGR 20<br>-----  | MGR 30<br>-----  | MGR 40<br>-----  | MGR 50<br>-----  | MGR 60<br>-----  | MGR 70<br>-----  | MGR 80<br>-----  | MGR 90<br>-----  |
| USERS<br>→           | USER 01<br>----- | USER 11<br>----- | USER 21<br>----- | USER 31<br>----- | USER 41<br>----- | USER 51<br>----- | USER 61<br>----- | USER 71<br>----- | USER 81<br>----- | USER 91<br>----- |
| USERS<br>→           | USER 02<br>----- | USER 12<br>----- | USER 22<br>----- | USER 32<br>----- | USER 42<br>----- | USER 52<br>----- | USER 62<br>----- | USER 72<br>----- | USER 82<br>----- | USER 92<br>----- |
| USERS<br>→           | USER 03<br>----- | USER 13<br>----- | USER 23<br>----- | USER 33<br>----- | USER 43<br>----- | USER 53<br>----- | USER 63<br>----- | USER 73<br>----- | USER 83<br>----- | USER 93<br>----- |
| USERS<br>→           | USER 04<br>----- | USER 14<br>----- | USER 24<br>----- | USER 34<br>----- | USER 44<br>----- | USER 54<br>----- | USER 64<br>----- | USER 74<br>----- | USER 84<br>----- | USER 94<br>----- |
| USERS<br>→           | USER 05<br>----- | USER 15<br>----- | USER 25<br>----- | USER 35<br>----- | USER 45<br>----- | USER 55<br>----- | USER 65<br>----- | USER 75<br>----- | USER 85<br>----- | USER 95<br>----- |
| USERS<br>→           | USER 06<br>----- | USER 16<br>----- | USER 26<br>----- | USER 36<br>----- | USER 46<br>----- | USER 56<br>----- | USER 66<br>----- | USER 76<br>----- | USER 86<br>----- | USER 96<br>----- |
| USERS<br>→           | USER 07<br>----- | USER 17<br>----- | USER 27<br>----- | USER 37<br>----- | USER 47<br>----- | USER 57<br>----- | USER 67<br>----- | USER 77<br>----- | USER 87<br>----- | USER 97<br>----- |
| USERS<br>→           | USER 08<br>----- | USER 18<br>----- | USER 28<br>----- | USER 38<br>----- | USER 48<br>----- | USER 58<br>----- | USER 68<br>----- | USER 78<br>----- | USER 88<br>----- | USER 98<br>----- |
| USERS<br>→           | USER 09<br>----- | USER 19<br>----- | USER 29<br>----- | USER 39<br>----- | USER 49<br>----- | USER 59<br>----- | USER 69<br>----- | USER 79<br>----- | USER 89<br>----- | USER 99<br>----- |

MASTER CODE

SERVICE CODE 1

SERVICE CODE 2

SERVICE CODE 3

LOCK DESCRIPTION

# Manager & User Location Example

User Access Codes allow access only; *Manager Codes* allow more: Manager Codes have the ability to program and delete User Access Codes within that Manager's Bank (column). The lock can hold up to 10 Manager Codes, one for each Bank (locations (00), (10), (20), (30), (40), (50), (60), (70), (80), (90)), and are all found at the top row of the grid below. **Note:** Only the Master Code can add or delete a Manager Code.

In addition, Managers not only possess programming abilities for User Access Codes residing in their own Bank, but also for *all higher Banks until the next programmed Manager Code appears*.

For example (see shaded grid below), if Manager Codes are programmed for locations (00) and (60), then the Manager in location (00) has control of the gray-shaded locations (00-09, 11-19, 21-29, 31-39, 41-49, and 51-59). The Manager in location (60) then has control over the black-shaded locations (61-69, 71-79, 81-89, and 91-99).

**Note:** If you wish to grant any Manager the ability to program any User, use the "Disable Groups" Function on page 9 (Enter the Master Code, then press     ).

|                      | (BANK 0)                                      | (BANK 1)          | (BANK 2)          | (BANK 3)          | (BANK 4)          | (BANK 5)          | (BANK 6)                                      | (BANK 7)          | (BANK 8)          | (BANK 9)          |
|----------------------|---|-------------------|-------------------|-------------------|-------------------|-------------------|---|-------------------|-------------------|-------------------|
| <b>MANAGERS</b><br>→ | MGR 00<br><i>Manager Code Programmed here</i> | MGR 10<br>(BLANK) | MGR 20<br>(BLANK) | MGR 30<br>(BLANK) | MGR 40<br>(BLANK) | MGR 50<br>(BLANK) | MGR 60<br><i>Manager Code Programmed here</i> | MGR 70<br>(BLANK) | MGR 80<br>(BLANK) | MGR 90<br>(BLANK) |
| <b>USERS</b><br>→    | USER 01                                       | USER 11           | USER 21           | USER 31           | USER 41           | USER 51           | USER 61                                       | USER 71           | USER 81           | USER 91           |
| <b>USERS</b><br>→    | USER 02                                       | USER 12           | USER 22           | USER 32           | USER 42           | USER 52           | USER 62                                       | USER 72           | USER 82           | USER 92           |
| <b>USERS</b><br>→    | USER 03                                       | USER 13           | USER 23           | USER 33           | USER 43           | USER 53           | USER 63                                       | USER 73           | USER 83           | USER 93           |
| <b>USERS</b><br>→    | USER 04                                       | USER 14           | USER 24           | USER 34           | USER 44           | USER 54           | USER 64                                       | USER 74           | USER 84           | USER 94           |
| <b>USERS</b><br>→    | USER 05                                       | USER 15           | USER 25           | USER 35           | USER 45           | USER 55           | USER 65                                       | USER 75           | USER 85           | USER 95           |
| <b>USERS</b><br>→    | USER 06                                       | USER 16           | USER 26           | USER 36           | USER 46           | USER 56           | USER 66                                       | USER 76           | USER 86           | USER 96           |
| <b>USERS</b><br>→    | USER 07                                       | USER 17           | USER 27           | USER 37           | USER 47           | USER 57           | USER 67                                       | USER 77           | USER 87           | USER 97           |
| <b>USERS</b><br>→    | USER 08                                       | USER 18           | USER 28           | USER 38           | USER 48           | USER 58           | USER 68                                       | USER 78           | USER 88           | USER 98           |
| <b>USERS</b><br>→    | USER 09                                       | USER 19           | USER 29           | USER 39           | USER 49           | USER 59           | USER 69                                       | USER 79           | USER 89           | USER 99           |

Manager Location Example

# Programming Worksheet: Functions

**Directions:** The Factory Master Code (1-2-3-4-5) must first be reprogrammed as a new Master Code before any other programming can take place. All new Access Codes must have the same number of digits as the new Master Code. Choose new Access Codes and write them in spaces provided (in pencil) before programming the lock. 6 beeps will usually be heard after an acceptable entry. **Note:** Managers *do not* have the ability to add/delete/enable/disable Users outside their Bank, unless Groups are disabled.

| FUNCTION                                 | PRESS THESE BUTTONS ON KEYPAD   |
|--|---|
| Change Existing Master Code              | [Enter Factory or Existing Master Code]    [Enter New Master Code _ _ _ _ _]<br>[Re-enter New Master Code _ _ _ _ _] [6 beeps = OK] |
| Add/Change Manager Codes (up to 10)      | [Enter Master Code]  [Enter 2-digit Manager Location _ _]<br>[Enter new Manager Code _ _ _ _ _] [6 beeps = OK]                      |
| Add/Change User Codes (up to 90)         | Press Master or Manager Code  [Enter 2-digit Location _ _]  [Enter new User Code _ _ _ _ _]<br>[6 beeps = OK]                       |
| Deleting Manager & User Codes            | Press Master or Manager Code  [Enter Bank Number] [Enter User Number]   |
| Disable / Disable User Number (Toggle)   | Press Master or Manager Code  [Enter Bank Number] [Enter User Number]  (wait)   |
| Disable All                              | Press Master or Manager Code      (Reset with Function 944)   |
| Enable All                               | Press Master or Manager Code  |
| Disable Users Only                       | Press Master or Manager Code      (Reset with Function 944)   |
| Code Location Function                   | Press Master or Manager Code    [Enter Code to be located]  |
| Next Free Code--Address Locator          | Press Master or Manager Code    [Responds with Bank # and User #]   |
| Service Code 1                           | Press Master or Manager Code      [Enter new Service Code _ _ _ _ _]  |
| Service Code 2                           | Press Master or Manager Code      [Enter new Service Code _ _ _ _ _]  |
| Service Code 3                           | Press Master or Manager Code      [Enter new Service Code _ _ _ _ _]  |
| Clear Service Codes                      | Press Master or Manager Code  |
| Enable Passage Mode                      | Press Master or Manager Code  |
| Disable Passage Mode                     | Press Master or Manager Code  |
| Pass Time ("Door Unlock")                | Press Master Code   [Enter "02" - "20" seconds]   |
| Enable Groups                            | Press Master Code   |
| Disable Groups                           | Press Master Code   |
| Disable Users In Bank                    | Press Master or Manager Code    [Enter Bank Number (0-9)]   |
| Enable Users in Bank                     | Press Master or Manager Code    [Enter Bank Number (0-9)]   |
| High Freq KP Feedback + LED              | Press Master Code   |
| Low Freq KP Feedback + LED               | Press Master Code      (With Mortise locks: Keypress "clicks" and entry/error "beeps")  |
| Click! KP Feedback + LED                 | Press Master Code      (With Mortise locks: Keypress "clicks" and entry/error silent)   |
| LED Only ("library mode")                | Press Master Code      All lock models completely silent ("library mode")   |
| Chirp on Emergency                       | Press Master Code      ("LD" Lock models with Emergency functions only)   |
| No Chirp on Emergency                    | Press Master Code      ("LD" Lock models with Emergency functions only)   |
| Remote Switch Input Default (see page 2) | Press Master Code      (2 white wires operate normal remote release)  |
| Remote Switch Input Toggle Passage       | Press Master Code      (Short beep = passage entry; long beep = passage exit)   |
| Disable AUX Relay Function               | Press Master Code   |
| AUX Relay on any First Keypress (0-9)    | Press Master Code   |
| AUX Relay When Unlocked                  | Press Master Code   |
| Lock Identifier                          | [Any Digit] [Any Digit]  [Listen for musical tones]   |



# Programming Functions

## Change Existing Master Code\*

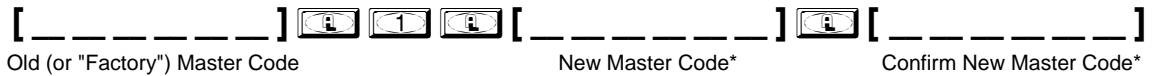
For new locks, follow the "Quick Start" on page 2. Factory Master Code MUST be re-programmed; allows lock configuration, passage and user management functions.



## Add/Change Manager Codes [ \_ ]

Follow the "Quick Start" on page 3. **Note:** You can also add/change the Manager Code in location 00 by entering the Master Code,    then the new Manager Code. Allows passage and user management functions.

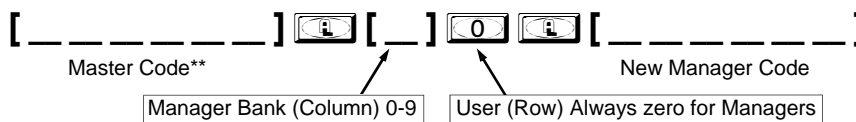

## Add/Change User Codes [ \_ \_ ]

Follow the "Quick Start" on page 3.

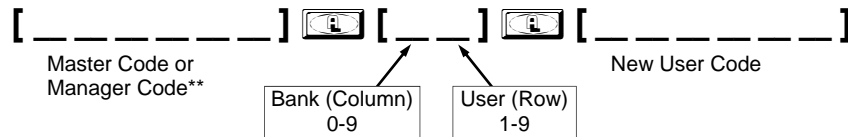

## Deleting Manager & User Codes [ \_ \_ ]

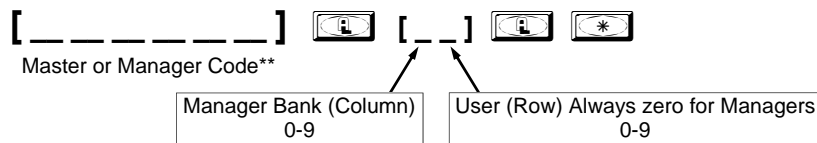

Follow the "Quick Start" on page 3.



## Disable/Enable Users (Toggle)

Enter the Master Code to disable / enable any Manager or User, or enter a Manager Code to disable any User within the Manager's Bank.

**Disable User Number** [ \_\_\_\_\_ ]  [ \_ \_ ]  (Allow system to relocate)  
Master or Manager Code Bank/User Number

**Enable User Number** [ \_\_\_\_\_ ]  [ \_ \_ ]  (Allow system to relocate)  
Master or Manager Code Bank/User Number

\* Once the number of digits is selected, it cannot be changed unless all programming is erased and the Factory Default settings are re-loaded (power must be removed and re-applied as per the "Erase All Programming" procedure found on page 12.  
 \*\* Required only if the unit is locked.





# Programming Functions (cont'd)





## Enable/Disable All





**Disable All:** If Master Code is used, disables all 100 User/Manager Codes and clears all 3 Service Codes. If a Manager Code is used, disables all Users (even across multiple Banks) under that Manager.

**Disable Users Only:** If Master Code is used, disables all 90 Users and clears all 3 Service Codes, while Managers remain active. If a Manager Code is used, disables all Users (even across multiple banks) under that Manager.

**Enable All:** If Master Code is used, re-enables all 100 User/Manager Codes (Service Codes must be re-programmed). If a Manager Code is used, re-enables all Users (even across multiple Banks) under that Manager. **Note:** Managers cannot disable themselves. Use Function 944 to restore Functions 955 and 950. In addition, if Codes are disabled using Function 955 or 950, and a new User Code is subsequently added (or an existing Code changed), the new (or changed) User Code will automatically become enabled.



**Disable All** [ \_ \_ \_ \_ \_ ]       
Master/Manager Code\*\*

**Disable Users Only** [ \_ \_ \_ \_ \_ ]       
Master/Manager Code\*\*

**Enable All** [ \_ \_ \_ \_ \_ ]       
Master/Manager Code\*\*

## Code Location Function

Be sure to record all Code locations in the blank worksheet (page 4; also pages 13, 14 and 15) for future reference. If the location of a Code is not known, use this function to find the Code. The lock will identify the BANK (0-9) and USER (0-9) by beeping and flashing the GREEN LED 0 to 9 times as detailed below.

[ \_ \_ \_ \_ \_ ]    [ \_ \_ \_ \_ \_ ]  
Master/Manager Code\*\* Code 2 - 6 digits



**If the code entered is recognized, the following sequence will occur:**

1. At the start of the Code Location sequence, the lock will Flash both the GREEN and RED LEDs and will emit a low tone.
2. The lock will identify the **Bank** number by flashing the GREEN LED and beeping the sounder from 0 -9 times.
3. To signify the end of the Bank number ID sequence, the lock will flash both the GREEN and RED LEDs and will emit a low tone.
4. The lock will identify the **User** number by flashing the GREEN LED and beeping the sounder from 0-9 times.
5. To signify the end of the Code Location function, the lock will flash both the GREEN and RED LEDs and will emit a low tone.

**Note:** Should the Code not be recognized, the lock will sound 5 beeps with a RED LED. **When the Bank and/or slot numbers are zero, the GREEN LED will not flash and the sounder will not beep.**

## Next Free Code Address Locator

Using the same method of beeps and flashes used in the Code Location Function, and dependent on the Master or Managers Code entered, the lock will report the next available address for User Access Code programming.

[ \_ \_ \_ \_ \_ ]     
Master/Manager Code\*\*

### Report Sequence



1. At the start of the Next Free Code Location function, the lock will Flash both the GREEN and RED LEDs and will emit a low tone.
2. The lock will identify the **Bank** number by flashing the GREEN LED and beeping the sounder from 0 - 9 times.
3. To signify the end of the Bank number ID sequence, the lock will flash both the GREEN and RED LEDs and will emit a low tone.
4. The lock will identify the **User** number by flashing the GREEN LED and beeping the sounder from 0- 9 times.
5. To signify the end of the Code Location function, the lock will flash both the GREEN and RED LEDs and will emit a low tone. If no free address is found, then the lock will emit a programming error tone sequence. **No LED flashes/sounder beeps represent the number zero.**

\*\* Required only if the unit is locked.



# Programming Functions (cont'd)





## Add/Delete Service Codes

Service Codes are one-time-only Codes; once entered into the keypad, it is deleted. Use the same Code up to 3 times by programming all three Service Codes with the same Code. **Note:** Service Codes are lost if power is removed. To delete a single Service Code, press , enter Service Code number (301, 302 or 303), then press  .

**Service Code 1** [ \_\_\_\_\_ ]      [ \_\_\_\_\_ ]  
Master/Manager Code\*\* New Service Code

**Service Code 2** [ \_\_\_\_\_ ]      [ \_\_\_\_\_ ]  
Master/Manager Code\*\* New Service Code



**Service Code 3** [ \_\_\_\_\_ ]      [ \_\_\_\_\_ ]  
Master/Manager Code\*\* New Service Code

**Delete All Service Codes** [ \_\_\_\_\_ ]       
Master/Manager Code\*\*

## Enable/Disable Passage Mode



Allows passage without the need to enter a Code into the keypad.

**Enable Passage Mode** [ \_\_\_\_\_ ]    ("Unlocked")  
Master or Manager Code\*\*

**Disable Passage Mode** [ \_\_\_\_\_ ]    ("Normal Operation")  
Master or Manager Code\*\*

## Pass Time ("Door Unlock")





The Pass Time is the time the lock stays unlocked after a valid Code entry. Use the function below to change the Pass Time from 02 to 20 seconds. The Pass Time factory default is 5 seconds. **NOTE:** The Pass Time will also determine the amount of time allowed between keypresses during programming.





**Pass Time** [ \_\_\_\_\_ ]   [ \_\_\_\_ ]   
Master Code\*\* Pass Time

## Disable/Enable Groups

**Disable Groups:** All Managers can program all User Access Codes, regardless of Bank.

**Enable Groups:** (Factory default) Managers restricted to controlling only those User Access Codes within their own Bank (column), and all following Banks until another Manager appears. User Access Codes in Banks outside of that Manager's Bank cannot be programmed.

**Disable Groups** [ \_\_\_\_\_ ]       
Master Code\*\*





**Enable Groups** [ \_\_\_\_\_ ]       
Master Code\*\*





\*\* Required only if the unit is locked.

# Programming Functions (cont'd)

## Disable/Enable Users in Bank

Enter Bank number (0-9) to Enable/Disable all Users in Bank. Entering a disabled Code will result in an accented five beep error tone (indicating the User Access Code is valid but disabled).





**Disable Users in Bank** [ \_ \_ \_ \_ \_ ]    [ \_ ]   
Master/Manager Code\*\* Bank Number





**Enable Users in Bank** [ \_ \_ \_ \_ \_ ]    [ \_ ]   
Master/Manager Code\*\* Bank Number





## Keypress Sound Options





The lock is capable of emitting 1 of 4 possible keypress sounds:

- **High Frequency Keypress Feedback + LED**
- **Low Frequency Keypress Feedback + LED** (With Mortise locks: Keypress "clicks" and entry/error normal "beeps")
- **"Click!" Keypress Feedback + LED** (With Mortise locks: Keypress "clicks" and entry/error silent)
- **LED Only:** All lock models completely silent ("library mode")

**High Freq KP Keypress Sound + LED (Default)** [ \_ \_ \_ \_ \_ ]       
Master Code\*\*





**Low Freq KP Keypress Sound + LED** [ \_ \_ \_ \_ \_ ]       
(Mortise: Keypress "clicks" and entry/error normal "beeps")  
Master Code\*\*





**Click! KP Keypress Sound + LED** [ \_ \_ \_ \_ \_ ]       
(Mortise: Keypress "clicks" and entry/error silent)  
Master Code\*\*





**LED Only** [ \_ \_ \_ \_ \_ ]       
All lock models completely silent ("library mode")  
Master Code\*\*

## AUX Relay Functions

Program the functions below to activate the Auxiliary Relay on any numeric keypress (Function 201), or when the unit is unlocked (Function 202). In either case the Aux Relay will be active for the duration programmed in Pass Time. See page 2 for information regarding the wiring of AUX leads.

**Disable AUX Relay Function** [ \_ \_ \_ \_ \_ ]       
Master Code\*\*

**AUX Relay on Any First Keypress (0-9)** [ \_ \_ \_ \_ \_ ]       
Master Code\*\*

**AUX Relay When Unlocked** [ \_ \_ \_ \_ \_ ]       
Master Code\*\*

## Lock Identifier





To aid in distinguishing your lock model from earlier Alarm Lock versions, your lock model will respond to any two digits plus the star key by (1) lighting the green LED and (2) playing a musical scale of 8 notes.





**Lock Identifier** [ \_ ] [ \_ ]   
(Any Two Digits)

# Programming Functions (cont'd)

## Enable / Disable Emergency Chirp





For "LD" Lock models with Emergency Lockdown functions only, the lock can be made to sound a chirp when an Emergency command is in effect.





**Chirp on Emergency** [ \_ \_ \_ \_ \_ ]       
Master Code\*\*

**No Chirp on Emergency** [ \_ \_ \_ \_ \_ ]       
Master Code\*\*

## Remote Switch Input Wires Toggle Passage Mode

The two white Remote Switch Input wires can be programmed to Toggle Passage Mode. To revert back to the default Remote Switch Input operation, use





**Default Remote Switch Input Operation** [ \_ \_ \_ \_ \_ ]       
Master Code\*\*

**Remote Switch Input Wires Toggle Passage** [ \_ \_ \_ \_ \_ ]       
Master Code\*\*

## Audible and LED Indications

When a key is pressed, a beep will sound and a Red LED will flash. Other indications are:

- **Access Granted:** 1 beep and a Green LED flash. (When Pass Time ends, the unit locks with a beep and a Red LED flash).
- **Invalid Code Entered:** 5 beeps and 5 Red LED flashes.
- **Disabled Code Entered:** 5 beeps (with extended first beep) and 5 Red LED flashes.
- **New Access Code Accepted:** 6 beeps and 6 Red LED flashes.
- **Programming Error:** 2 sets of 5 beeps and 5 Red LED flashes.
- **Return from Anti Tamper Lockout:** 2 beeps with a Red LED flash.
- **Low Battery:** High/Low sounder with flashing Red LED for 5 seconds. (See below to replace batteries).

**Note:** Keypress tones may be disabled using the      command (see Keypress Sound Options, page 10).

## Battery Replacement

When the batteries are weak and a key is pressed, the lock will alert you by flashing the RED LED accompanied by a high/low sounder. The lock uses five AA-size 1.5 volt alkaline batteries; although the lock will function with weak batteries, be sure to replace them with fresh batteries as soon as possible.



1. Remove the screw at the rear of the lock housing and remove the cover.
2. Remove battery pack and replace all 5 batteries.
3. Replace battery pack. Do not press any keys for 10 seconds.

If you do not hear any beeps or if you hear 3 beeps (one per second), the previous lock programming is retained and the unit is now ready for use.

4. Replace cover and tighten the cover screw to secure.

## Erase All Programming

Restore Factory Default (original settings that were set at the factory will be loaded).

1. Remove the battery pack, and with the batteries disconnected, press any numeric key for 10 seconds and release.
2. Connect the batteries and--within 3 seconds--press and hold . After hearing 6 additional beeps, release .

The lock is now clear of all programmed data and is now ready to accept new programming. **Important:** If you do not hear these 6 beeps, you must start over at step 1.

 Failure to follow this exact procedure can result in erratic lock behavior.

# Manager & User Location Worksheet

The lock provides three "maintenance levels": **Master** (can perform ALL functions), **Manager** (can perform SOME programming functions plus entry), and **Basic User** (entry only). In total, there are 104 "locations" inside the lock: one Master Code, 10 Manager and 90 User Access Codes, and three "one-time entry" Service Codes. *Where the Access Code is located will determine its "maintenance level"*. From the factory, all locations (except for the Master Code) are empty; each location can then be programmed to contain an Access Code, and these Access Codes enable Users to program and/or unlock the lock. As a visual aid, the 100 Manager/User Access Code locations are detailed in the grid below, with ten "Banks" (columns) of ten "Managers/Users" (rows). Each of the 100 squares in the grid is identified by a unique two-digit location (00) through (99). Notice that these two digits also specify its Bank (column) and Manager/User (row) location in the grid. Also notice that all Managers are in the top row, their locations all ending in a zero (locations 00, 10, 20, 30 and so on through 90). **Note:** Use the blank grid below as a **Programming Worksheet** for preparing all programming in advance. Store this worksheet in a safe place for future reference.

Each square represents a location inside the lock (excluding the Master Code and the 3 Service Codes). Each location can hold one "User Access Code" which can unlock the lock.

|                      | BANK 0           | BANK 1           | BANK 2           | BANK 3           | BANK 4           | BANK 5           | BANK 6           | BANK 7           | BANK 8           | BANK 9           |
|----------------------|------------------|------------------|------------------|------------------|------------------|------------------|------------------|------------------|------------------|------------------|
| <b>MANAGERS</b><br>→ | MGR 00<br>-----  | MGR 10<br>-----  | MGR 20<br>-----  | MGR 30<br>-----  | MGR 40<br>-----  | MGR 50<br>-----  | MGR 60<br>-----  | MGR 70<br>-----  | MGR 80<br>-----  | MGR 90<br>-----  |
| USERS<br>→           | USER 01<br>----- | USER 11<br>----- | USER 21<br>----- | USER 31<br>----- | USER 41<br>----- | USER 51<br>----- | USER 61<br>----- | USER 71<br>----- | USER 81<br>----- | USER 91<br>----- |
| USERS<br>→           | USER 02<br>----- | USER 12<br>----- | USER 22<br>----- | USER 32<br>----- | USER 42<br>----- | USER 52<br>----- | USER 62<br>----- | USER 72<br>----- | USER 82<br>----- | USER 92<br>----- |
| USERS<br>→           | USER 03<br>----- | USER 13<br>----- | USER 23<br>----- | USER 33<br>----- | USER 43<br>----- | USER 53<br>----- | USER 63<br>----- | USER 73<br>----- | USER 83<br>----- | USER 93<br>----- |
| USERS<br>→           | USER 04<br>----- | USER 14<br>----- | USER 24<br>----- | USER 34<br>----- | USER 44<br>----- | USER 54<br>----- | USER 64<br>----- | USER 74<br>----- | USER 84<br>----- | USER 94<br>----- |
| USERS<br>→           | USER 05<br>----- | USER 15<br>----- | USER 25<br>----- | USER 35<br>----- | USER 45<br>----- | USER 55<br>----- | USER 65<br>----- | USER 75<br>----- | USER 85<br>----- | USER 95<br>----- |
| USERS<br>→           | USER 06<br>----- | USER 16<br>----- | USER 26<br>----- | USER 36<br>----- | USER 46<br>----- | USER 56<br>----- | USER 66<br>----- | USER 76<br>----- | USER 86<br>----- | USER 96<br>----- |
| USERS<br>→           | USER 07<br>----- | USER 17<br>----- | USER 27<br>----- | USER 37<br>----- | USER 47<br>----- | USER 57<br>----- | USER 67<br>----- | USER 77<br>----- | USER 87<br>----- | USER 97<br>----- |
| USERS<br>→           | USER 08<br>----- | USER 18<br>----- | USER 28<br>----- | USER 38<br>----- | USER 48<br>----- | USER 58<br>----- | USER 68<br>----- | USER 78<br>----- | USER 88<br>----- | USER 98<br>----- |
| USERS<br>→           | USER 09<br>----- | USER 19<br>----- | USER 29<br>----- | USER 39<br>----- | USER 49<br>----- | USER 59<br>----- | USER 69<br>----- | USER 79<br>----- | USER 89<br>----- | USER 99<br>----- |

MASTER CODE

SERVICE CODE 1

SERVICE CODE 2

SERVICE CODE 3

LOCK DESCRIPTION

# Manager & User Location Worksheet

The lock provides three "maintenance levels": **Master** (can perform ALL functions), **Manager** (can perform SOME programming functions plus entry), and **Basic User** (entry only). In total, there are 104 "locations" inside the lock: one Master Code, 10 Manager and 90 User Access Codes, and three "one-time entry" Service Codes. *Where the Access Code is located will determine its "maintenance level"*. From the factory, all locations (except for the Master Code) are empty; each location can then be programmed to contain an Access Code, and these Access Codes enable Users to program and/or unlock the lock. As a visual aid, the 100 Manager/User Access Code locations are detailed in the grid below, with ten "Banks" (columns) of ten "Managers/Users" (rows). Each of the 100 squares in the grid is identified by a unique two-digit location (00) through (99). Notice that these two digits also specify its Bank (column) and Manager/User (row) location in the grid. Also notice that all Managers are in the top row, their locations all ending in a zero (locations 00, 10, 20, 30 and so on through 90). **Note:** Use the blank grid below as a **Programming Worksheet** for preparing all programming in advance. Store this worksheet in a safe place for future reference.

Each square represents a location inside the lock (excluding the Master Code and the 3 Service Codes). Each location can hold one "User Access Code" which can unlock the lock.

|                      | BANK 0           | BANK 1           | BANK 2           | BANK 3           | BANK 4           | BANK 5           | BANK 6           | BANK 7           | BANK 8           | BANK 9           |
|----------------------|------------------|------------------|------------------|------------------|------------------|------------------|------------------|------------------|------------------|------------------|
| <b>MANAGERS</b><br>→ | MGR 00<br>-----  | MGR 10<br>-----  | MGR 20<br>-----  | MGR 30<br>-----  | MGR 40<br>-----  | MGR 50<br>-----  | MGR 60<br>-----  | MGR 70<br>-----  | MGR 80<br>-----  | MGR 90<br>-----  |
| USERS<br>→           | USER 01<br>----- | USER 11<br>----- | USER 21<br>----- | USER 31<br>----- | USER 41<br>----- | USER 51<br>----- | USER 61<br>----- | USER 71<br>----- | USER 81<br>----- | USER 91<br>----- |
| USERS<br>→           | USER 02<br>----- | USER 12<br>----- | USER 22<br>----- | USER 32<br>----- | USER 42<br>----- | USER 52<br>----- | USER 62<br>----- | USER 72<br>----- | USER 82<br>----- | USER 92<br>----- |
| USERS<br>→           | USER 03<br>----- | USER 13<br>----- | USER 23<br>----- | USER 33<br>----- | USER 43<br>----- | USER 53<br>----- | USER 63<br>----- | USER 73<br>----- | USER 83<br>----- | USER 93<br>----- |
| USERS<br>→           | USER 04<br>----- | USER 14<br>----- | USER 24<br>----- | USER 34<br>----- | USER 44<br>----- | USER 54<br>----- | USER 64<br>----- | USER 74<br>----- | USER 84<br>----- | USER 94<br>----- |
| USERS<br>→           | USER 05<br>----- | USER 15<br>----- | USER 25<br>----- | USER 35<br>----- | USER 45<br>----- | USER 55<br>----- | USER 65<br>----- | USER 75<br>----- | USER 85<br>----- | USER 95<br>----- |
| USERS<br>→           | USER 06<br>----- | USER 16<br>----- | USER 26<br>----- | USER 36<br>----- | USER 46<br>----- | USER 56<br>----- | USER 66<br>----- | USER 76<br>----- | USER 86<br>----- | USER 96<br>----- |
| USERS<br>→           | USER 07<br>----- | USER 17<br>----- | USER 27<br>----- | USER 37<br>----- | USER 47<br>----- | USER 57<br>----- | USER 67<br>----- | USER 77<br>----- | USER 87<br>----- | USER 97<br>----- |
| USERS<br>→           | USER 08<br>----- | USER 18<br>----- | USER 28<br>----- | USER 38<br>----- | USER 48<br>----- | USER 58<br>----- | USER 68<br>----- | USER 78<br>----- | USER 88<br>----- | USER 98<br>----- |
| USERS<br>→           | USER 09<br>----- | USER 19<br>----- | USER 29<br>----- | USER 39<br>----- | USER 49<br>----- | USER 59<br>----- | USER 69<br>----- | USER 79<br>----- | USER 89<br>----- | USER 99<br>----- |

MASTER CODE

SERVICE CODE 1

SERVICE CODE 2

SERVICE CODE 3

\_\_\_\_\_  
LOCK DESCRIPTION

# Manager & User Location Worksheet

The lock provides three "maintenance levels": **Master** (can perform ALL functions), **Manager** (can perform SOME programming functions plus entry), and **Basic User** (entry only). In total, there are 104 "locations" inside the lock: one Master Code, 10 Manager and 90 User Access Codes, and three "one-time entry" Service Codes. *Where the Access Code is located will determine its "maintenance level"*. From the factory, all locations (except for the Master Code) are empty; each location can then be programmed to contain an Access Code, and these Access Codes enable Users to program and/or unlock the lock. As a visual aid, the 100 Manager/User Access Code locations are detailed in the grid below, with ten "Banks" (columns) of ten "Managers/Users" (rows). Each of the 100 squares in the grid is identified by a unique two-digit location (00) through (99). Notice that these two digits also specify its Bank (column) and Manager/User (row) location in the grid. Also notice that all Managers are in the top row, their locations all ending in a zero (locations 00, 10, 20, 30 and so on through 90). **Note:** Use the blank grid below as a **Programming Worksheet** for preparing all programming in advance. Store this worksheet in a safe place for future reference.

Each square represents a location inside the lock (excluding the Master Code and the 3 Service Codes). Each location can hold one "User Access Code" which can unlock the lock.

|                      | BANK 0           | BANK 1           | BANK 2           | BANK 3           | BANK 4           | BANK 5           | BANK 6           | BANK 7           | BANK 8           | BANK 9           |
|----------------------|------------------|------------------|------------------|------------------|------------------|------------------|------------------|------------------|------------------|------------------|
| <b>MANAGERS</b><br>→ | MGR 00<br>-----  | MGR 10<br>-----  | MGR 20<br>-----  | MGR 30<br>-----  | MGR 40<br>-----  | MGR 50<br>-----  | MGR 60<br>-----  | MGR 70<br>-----  | MGR 80<br>-----  | MGR 90<br>-----  |
| USERS<br>→           | USER 01<br>----- | USER 11<br>----- | USER 21<br>----- | USER 31<br>----- | USER 41<br>----- | USER 51<br>----- | USER 61<br>----- | USER 71<br>----- | USER 81<br>----- | USER 91<br>----- |
| USERS<br>→           | USER 02<br>----- | USER 12<br>----- | USER 22<br>----- | USER 32<br>----- | USER 42<br>----- | USER 52<br>----- | USER 62<br>----- | USER 72<br>----- | USER 82<br>----- | USER 92<br>----- |
| USERS<br>→           | USER 03<br>----- | USER 13<br>----- | USER 23<br>----- | USER 33<br>----- | USER 43<br>----- | USER 53<br>----- | USER 63<br>----- | USER 73<br>----- | USER 83<br>----- | USER 93<br>----- |
| USERS<br>→           | USER 04<br>----- | USER 14<br>----- | USER 24<br>----- | USER 34<br>----- | USER 44<br>----- | USER 54<br>----- | USER 64<br>----- | USER 74<br>----- | USER 84<br>----- | USER 94<br>----- |
| USERS<br>→           | USER 05<br>----- | USER 15<br>----- | USER 25<br>----- | USER 35<br>----- | USER 45<br>----- | USER 55<br>----- | USER 65<br>----- | USER 75<br>----- | USER 85<br>----- | USER 95<br>----- |
| USERS<br>→           | USER 06<br>----- | USER 16<br>----- | USER 26<br>----- | USER 36<br>----- | USER 46<br>----- | USER 56<br>----- | USER 66<br>----- | USER 76<br>----- | USER 86<br>----- | USER 96<br>----- |
| USERS<br>→           | USER 07<br>----- | USER 17<br>----- | USER 27<br>----- | USER 37<br>----- | USER 47<br>----- | USER 57<br>----- | USER 67<br>----- | USER 77<br>----- | USER 87<br>----- | USER 97<br>----- |
| USERS<br>→           | USER 08<br>----- | USER 18<br>----- | USER 28<br>----- | USER 38<br>----- | USER 48<br>----- | USER 58<br>----- | USER 68<br>----- | USER 78<br>----- | USER 88<br>----- | USER 98<br>----- |
| USERS<br>→           | USER 09<br>----- | USER 19<br>----- | USER 29<br>----- | USER 39<br>----- | USER 49<br>----- | USER 59<br>----- | USER 69<br>----- | USER 79<br>----- | USER 89<br>----- | USER 99<br>----- |

MASTER CODE

SERVICE CODE 1

SERVICE CODE 2

SERVICE CODE 3

\_\_\_\_\_  
LOCK DESCRIPTION

# ALARM LOCK LIMITED WARRANTY

ALARM LOCK SYSTEMS, INC. (ALARM LOCK) warrants its products to be free from manufacturing defects in materials and workmanship for twenty four months following the date of manufacture. ALARM LOCK will, within said period, at its option, repair or replace any product failing to operate correctly without charge to the original purchaser or user.

This warranty shall not apply to any equipment, or any part thereof, which has been repaired by others, improperly installed, improperly used, abused, altered, damaged, subjected to acts of God, or on which any serial numbers have been altered, defaced or removed. Seller will not be responsible for any dismantling or reinstallation charges, environmental wear and tear, normal maintenance expenses, or shipping and freight expenses required to return products to ALARM LOCK. Additionally, this warranty shall not cover scratches, abrasions or deterioration due to the use of paints, solvents or other chemicals.

THERE ARE NO WARRANTIES, EXPRESS OR IMPLIED, WHICH EXTEND BEYOND THE DESCRIPTION ON THE FACE HEREOF. THERE IS NO EXPRESS OR IMPLIED WARRANTY OF MERCHANTABILITY OR A WARRANTY OF FITNESS FOR A PARTICULAR PURPOSE. ADDITIONALLY, THIS WARRANTY IS IN LIEU OF ALL OTHER OBLIGATIONS OR LIABILITIES ON THE PART OF ALARM LOCK.

Any action for breach of warranty, including but not limited to any implied warranty of merchantability, must be brought within the six months following the end of the warranty period.

IN NO CASE SHALL ALARM LOCK BE LIABLE TO ANYONE FOR ANY CONSEQUENTIAL OR INCIDENTAL DAMAGES FOR BREACH OF THIS OR ANY OTHER WARRANTY, EXPRESS OR IMPLIED, EVEN IF THE LOSS OR DAMAGE IS CAUSED BY THE SELLER'S OWN NEGLIGENCE OR FAULT.

In case of defect, contact the security professional who installed and maintains your security system. In order to exercise the warranty, the product must be returned by the security professional, shipping costs prepaid and insured to ALARM LOCK. After repair or replacement, ALARM LOCK assumes the cost of returning products under warranty. ALARM LOCK shall have no obligation under this warranty, or otherwise, if the product has been repaired by others, improperly installed, improperly used, abused, altered, damaged, subjected to accident, nuisance, flood, fire or acts of God, or on which any serial numbers have been altered, defaced or removed. ALARM LOCK will not be responsible for any dismantling, reassembly or reinstallation charges, environmental wear and tear, normal maintenance expenses, or shipping and freight expenses required to return products to ALARM LOCK. Additionally, this warranty shall not cover scratches, abrasions or deterioration due to the use of paints, solvents or other chemicals.

This warranty contains the entire warranty. It is the sole warranty and any prior agreements or representations, whether oral or written, are either merged herein or are expressly cancelled. ALARM LOCK neither assumes, nor authorizes any other person purporting to act on its behalf to modify, to change, or to assume for it, any other warranty or liability concerning its products.

In no event shall ALARM LOCK be liable for an amount in excess of ALARM LOCK's original selling price of the product, for any loss or damage, whether direct, indirect, incidental, consequential, or otherwise arising out of any failure of the product. Seller's warranty, as hereinabove set forth, shall not be enlarged, diminished or affected by and no obligation or liability shall arise or grow out of Seller's rendering of technical advice or service in connection with Buyer's order of the goods furnished hereunder.

ALARM LOCK RECOMMENDS THAT THE ENTIRE SYSTEM BE COMPLETELY TESTED WEEKLY.

**Warning:** Despite frequent testing, and due to, but not limited to, any or all of the following; criminal tampering, electrical or communications disruption, it is possible for the system to fail to perform as expected. ALARM LOCK does not represent that the product/system may not be compromised or circumvented; or that the product or system will prevent any personal injury or property loss by burglary, robbery, fire or otherwise; nor that the product or system will in all cases provide adequate warning or protection. A properly installed and maintained alarm may only reduce risk of burglary, robbery, fire or otherwise but it is not insurance or a guarantee that these events will not occur. CONSEQUENTLY, SELLER SHALL HAVE NO LIABILITY FOR ANY PERSONAL INJURY, PROPERTY DAMAGE, OR OTHER LOSS BASED ON A CLAIM THE PRODUCT FAILED TO GIVE WARNING. Therefore, the installer should in turn advise the consumer to take any and all precautions for his or her safety including, but not limited to, fleeing the premises and calling police or fire department, in order to mitigate the possibilities of harm and/or damage.

ALARM LOCK is not an insurer of either the property or safety of the user's family or employees, and limits its liability for any loss or damage including incidental or consequential damages to ALARM LOCK's original selling price of the product regardless of the cause of such loss or damage.

Some states do not allow limitations on how long an implied warranty lasts or do not allow the exclusion or limitation of incidental or consequential damages, or differentiate in their treatment of limitations of liability for ordinary or gross negligence, so the above limitations or exclusions may not apply to you. This Warranty gives you specific legal rights and you may also have other rights which vary from state to state.



# PROGRAMMING T2 FUNCTIONS

To program desired function, follow procedure in right column (assumes Master Code is programmed first).

| FUNCTION                              | PRESS THESE BUTTONS ON KEYPAD   |
|---------------------------------------|---|
| Pass Time ("Door Unlock")             | Press Master Code   [Enter between "02" ( ) through "20" ( ) "20" seconds] then press                               |
| Enable Groups                         | Press Master Code   |
| Disable Groups                        | Press Master Code   |
| Disable Users In Bank                 | Press Master or Manager Code    [Enter Bank Number (0-9)]   |
| Enable Users in Bank                  | Press Master or Manager Code    [Enter Bank Number (0-9)]   |
| Disable / Enable User Number (Toggle) | Press Master or Manager Code  [Enter Bank Number] [Enter User Number]  (wait for beeps and for the lock to re-lock) |
| Disable All                           | Press Master or Manager Code      (Reset with Function 944)   |
| Enable All                            | Press Master or Manager Code  |
| Disable Users Only                    | Press Master or Manager Code      (Reset with Function 944)   |

Fold on Line

## T2 QUICK-REFERENCE GUIDE TO PROGRAMMING CODES AND FUNCTIONS















































345 Bayview Avenue  
Amityville, New York 11701  
For Sales and Repairs 1-800-ALA-LOCK  
For Technical Service 1-800-645-9440

Publicly traded on NASDAQ

Symbol: NSSC

# QUICK REFERENCE GUIDE TO PROGRAMMING CODES

**INSTRUCTIONS:** To program desired function, follow procedure in right column.

| FUNCTION   | PRESS THESE BUTTONS ON KEYPAD   |
|--|---|
| <b>Restore Factory Default</b><br>(Load original factory settings) | 1. Remove the battery pack, and with the batteries disconnected, press any numeric key for 10 seconds and release.<br>2. Connect batteries and--within 3 seconds--press and hold  . After hearing 6 additional beeps, release  .<br><b>Important:</b> If you do not hear 6 beeps, you must start over at step 1.  |
| Change Existing Master Code  | [Enter Factory or Existing Master Code]    [Enter New Master Code _ _ _ _ _ ] <br>[Re-enter New Master Code _ _ _ _ _ ] [6 beeps = OK].<br>Factory Master Code MUST be re-programmed; allows lock configuration, passage and user management functions. |
| Add/Change Manager Codes<br>(up to 10 Manager Codes allowed)       | [Enter Master Code]  [Enter 2-digit Manager Location _ _ ] <br>[Enter new Manager Code _ _ _ _ _ ] [6 beeps = OK].<br>Allows passage and user management functions.   |
| Add/Change User Codes<br>(up to 90 User Codes allowed)             | Press Master or Manager Code  [Enter 2-digit Location _ _ ]  [Enter new User Code _ _ _ _ _ ]<br>[6 beeps = OK]  |
| Deleting Manager & User Codes                                      | Press Master or Manager Code  [Enter Bank Number] [Enter User Number]     |
| Code Location Function   | Press Master or Manager Code    [Enter Code to be located]  |
| Next Free Code--Address Locator                                    | Press Master or Manager Code    [Responds with Bank # and User #]   |
| Service Code 1   | Press Master or Manager Code      [Enter new Service Code _ _ _ _ _ ]   |
| Service Code 2   | Press Master or Manager Code      [Enter new Service Code _ _ _ _ _ ]   |
| Service Code 3   | Press Master or Manager Code      [Enter new Service Code _ _ _ _ _ ]   |
| Clear Service Codes  | Press Master or Manager Code        |
| Enable Passage Mode  | Press Master or Manager Code      |
| Disable Passage Mode   | Press Master or Manager Code      |

# MODEL DL 2700WP LEVER SETS PARTS LIST

Standard Cylinder and Interchangeable Core Models

| Item                                    | S Part#   | Description               | Item   | Part #    |
|---|-----------|---------------------------|--------|-----------|
| 1a                                      | S6105-US3 | Battery Cover             | 1 + 8  | HW592-US3 |
| 1b                                      | S6105-US5 | Battery Cover             | 1 + 8  | HW592-US5 |
| 1c                                      | S6105-26D | Battery Cover             | 1 + 8  | HW592-26D |
| 1d                                      | S6105-26  | Battery Cover             | 1 + 8  | HW592-26  |
| 1e                                      | S6105-10B | Battery Cover             | 1 + 8  | HW592-10B |
| 2a                                      | S6106-US3 | Inside Lever              |        | HW615-US3 |
| 2b                                      | S6106-US5 | Inside Lever              |        | HW615-US5 |
| 2c                                      | S6106-26D | Inside Lever              |        | HW615-26D |
| 2d                                      | S6106-26  | Inside Lever              |        | HW615-26  |
| 2e                                      | S6106-10B | Inside Lever              |        | HW615-10B |
| <b>Thru Bolt/10-32x2-1/2", (2)</b>      |           |                           |        |           |
| 3a                                      | S6104-US3 | Flat Hd.,PH,MS            | 3+5+19 | SC458-US3 |
| 3b                                      | S6104-US5 | Flat Hd.,PH,MS            | 3+5+19 | SC458-US5 |
| 3c                                      | S6104-26D | Flat Hd.,PH,MS            | 3+5+19 | SC458-26D |
| 3d                                      | S6104-26  | Flat Hd.,PH,MS            | 3+5+19 | SC458-26  |
| 3e                                      | S6104-10B | Flat Hd.,PH,MS            | 3+5+19 | SC458-10B |
| 4a                                      | S6044-US3 | Inside Housing Ass'y      |        |           |
| 4b                                      | S6044-US5 | Inside Housing Ass'y      |        |           |
| 4c                                      | S6044-26D | Inside Housing Ass'y      |        |           |
| 4d                                      | S6044-26  | Inside Housing Ass'y      |        |           |
| 4e                                      | S6044-10B | Inside Housing Ass'y      |        |           |
| <b>Inside Mounting Screws (2)</b>       |           |                           |        |           |
| 5a                                      | S6104-US3 | #6-32x3/8", Oval Hd       | 3+5+19 | P1526-US3 |
| 5b                                      | S6104-US5 | #6-32x3/8", Oval Hd       | 3+5+19 | P1526-US5 |
| 5c                                      | S6104-26D | #6-32x3/8", Oval Hd       | 3+5+19 | P1526-26D |
| 5d                                      | S6104-26  | #6-32x3/8", Oval Hd       | 3+5+19 | P1526-26  |
| 5e                                      | S6104-10B | #6-32x3/8", Oval Hd       | 3+5+19 | P1526-10B |
| 6                                       | S6115     | Inside Mounting Plate     | 6 + 7  | HW594     |
| <b>Inside Mounting Plate Screws (2)</b> |           |                           |        |           |
| 7                                       | S6115     | #8-32x1", Flat Hd,PH,MS   | 6 + 7  | SC459     |
| 8a                                      | S6105-US3 | #4-40x1/4", Flat Hd,PH,MS | 1 + 8  | P5851-US3 |
| 8b                                      | S6105-US5 | #4-40x1/4", Flat Hd,PH,MS | 1 + 8  | P5851-US3 |
| 8c                                      | S6105-26D | #4-40x1/4", Flat Hd,PH,MS | 1 + 8  | P5851-26D |
| 8d                                      | S6105-26  | #4-40x1/4", Flat Hd,PH,MS | 1 + 8  | P5851-26D |
| 8e                                      | S6105-10B | #4-40x1/4", Flat Hd,PH,MS | 1 + 8  | P5851-10B |
| <b>Inside Rose Screws (2)</b>           |           |                           |        |           |
| 9                                       | S6103     | #10-32x1"w/#8PanHd,PH,MS  | 7 + 9  | SC457     |
| 10                                      | HW564     | Inside Rose               |        |           |
| 11                                      | S6045     | Lock Body Assembly        |        |           |
| 11A                                     | S6046     | IC Lock Body Ass'y        |        |           |
| 12a                                     | S6054-US3 | Outside Housing Ass'y     |        |           |
| 12b                                     | S6054-US5 | Outside Housing Ass'y     |        |           |
| 12c                                     | S6054-26D | Outside Housing Ass'y     |        |           |
| 12d                                     | S6054-26  | Outside Housing Ass'y     |        |           |
| 12e                                     | S6054-10B | Outside Housing Ass'y     |        |           |
| 13a                                     | S6111-US3 | Std. Cylinder Ass'y       |        | HW596-US3 |
| 13b                                     | S6111-26D | Std. Cylinder Ass'y       |        | HW596-26D |
| 14                                      | HW578     | Cylinder Retainer         |        |           |
| 15a                                     | S6110-US3 | Outside Lever             |        | HW614-US3 |
| 15b                                     | S6110-US5 | Outside Lever             |        | HW614-US5 |

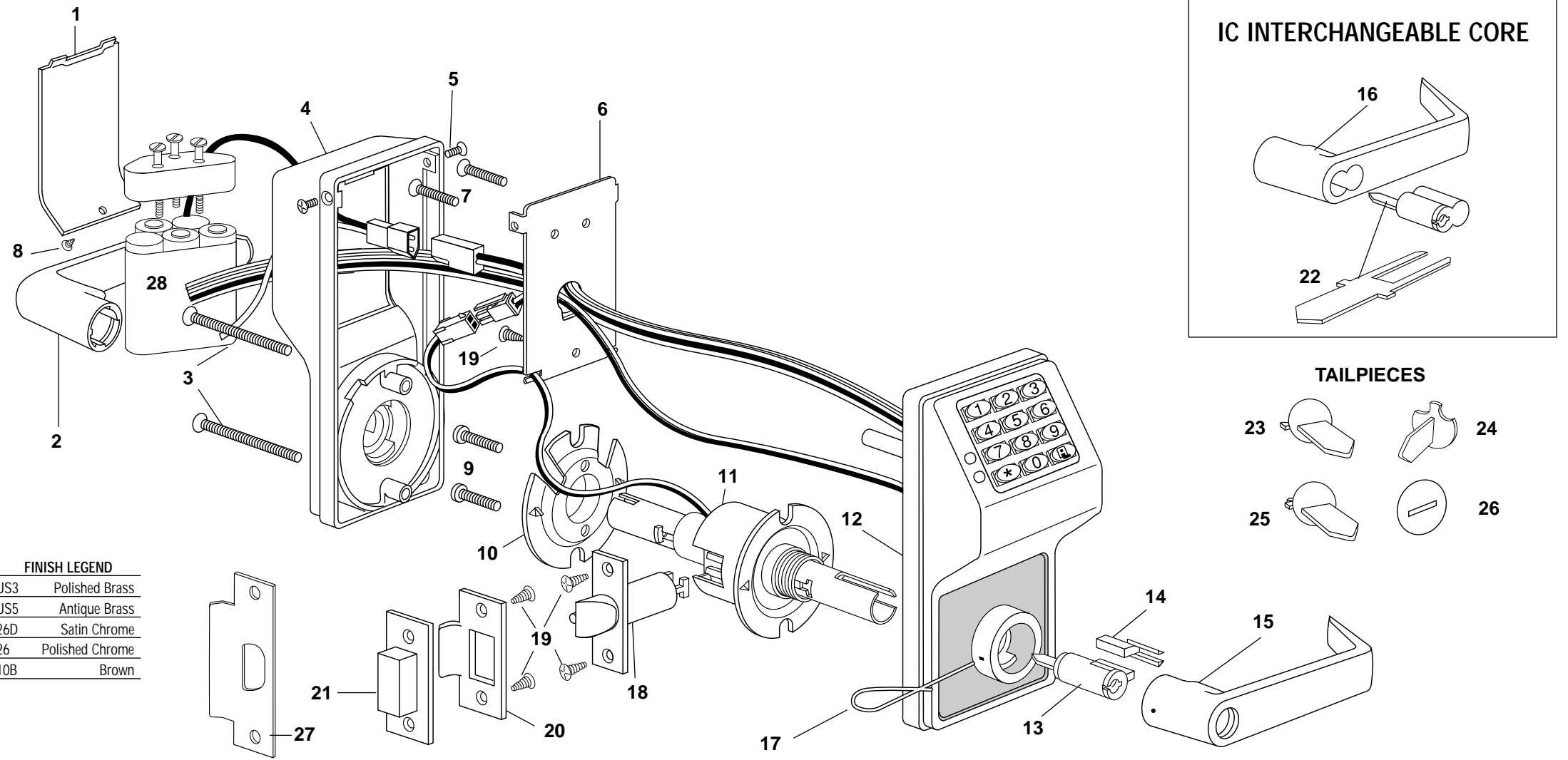

**FINISH LEGEND**

|     |                 |
|-----|-----------------|
| US3 | Polished Brass  |
| US5 | Antique Brass   |
| 26D | Satin Chrome    |
| 26  | Polished Chrome |
| 10B | Brown           |



| Item | S Part #  | Description            | Item   | Part #    |
|------|-----------|------------------------|--------|-----------|
| 15c  | S6110-26D | Outside Lever          |        | HW614-26D |
| 15d  | S6110-26  | Outside Lever          |        | HW614-26  |
| 15e  | S6110-10B | Outside Lever          |        | HW614-10B |
| 16a  | S6107-US3 | Outside Lever-IC Core  |        | HW616-US3 |
| 16b  | S6107-US5 | Outside Lever-IC Core  |        | HW616-US5 |
| 16c  | S6107-26D | Outside Lever-IC Core  |        | HW616-26D |
| 16d  | S6107-26  | Outside Lever-IC Core  |        | HW616-26  |
| 16e  | S6107-10B | Outside Lever-IC Core  |        | HW616-10B |
| 17   | HW618     | Lever Release Pin      |        |           |
| 18a  | S6112-US3 | Latch - 2-3/4" Backset |        |           |
| 18b  | S6112-US5 | Latch - 2-3/4" Backset |        |           |
| 18c  | S6112-26D | Latch - 2-3/4" Backset |        |           |
| 18d  | S6112-26  | Latch - 2-3/4" Backset |        |           |
| 18e  | S6112-10B | Latch - 2-3/4" Backset |        |           |
| 18a  | S6125-US3 | Latch - 2-3/8" Backset |        |           |
| 18b  | S6125-US5 | Latch - 2-3/8" Backset |        |           |
| 18c  | S6125-26D | Latch - 2-3/8" Backset |        |           |
| 18d  | S6125-26  | Latch - 2-3/8" Backset |        |           |
| 18e  | S6125-10B | Latch - 2-3/8" Backset |        |           |
| 19a  | S6104-US3 | #8x3/4" Combo screw    | 3+5+19 | SC460-US3 |
| 19b  | S6104-US5 | #8x3/4" Combo screw    | 3+5+19 | SC460-US5 |
| 19c  | S6104-26D | #8x3/4" Combo screw    | 3+5+19 | SC460-26D |

| Item | S Part #  | Description                | Item    | Part #    |
|------|-----------|----------------------------|---------|-----------|
| 19d  | S6104-26  | #8x3/4" Combo screw        | 3+5+19  | SC460-26  |
| 19e  | S6104-10B | #8x3/4" Combo screw        | 3+5+19  | SC460-10B |
| 20a  | S6114-US3 | Strike 2-3/4" x 1-1/8"     | 20 + 27 | HW577-US3 |
| 20b  | S6114-US5 | Strike 2-3/4" x 1-1/8"     | 20 + 27 | HW577-US5 |
| 20c  | S6114-26D | Strike 2-3/4" x 1-1/8"     | 20 + 27 | HW577-26D |
| 20d  | S6114-26  | Strike 2-3/4" x 1-1/8"     | 20 + 27 | HW577-26  |
| 20e  | S6114-10B | Strike 2-3/4" x 1-1/8"     | 20 + 27 | HW577-10B |
| 21   | P5847     | Dust Box                   |         |           |
| 22   | S6070-B   | IC Tail-Best,Arrow,Falcon  |         | HW598     |
| 23   | S6070-KIL | Std. Tailpiece             |         | HW597     |
| 24   | HW580     | Replace tailpiece-Schlage  |         |           |
| 25   | HW620     | Replace tailpiece for Lori |         |           |
| 26   | WA160     | Washer for all tailpieces  |         |           |
| 27a  | S6114-US3 | Strike 4-7/8" x 1-1/4"     | 20+27   | P5846-US3 |
| 27b  | S6114-US5 | Strike 4-7/8" x 1-1/4"     | 20+27   | P5846-US5 |
| 27c  | S6114-26D | Strike 4-7/8" x 1-1/4"     | 20+27   | P5846-26D |
| 27d  | S6114-26  | Strike 4-7/8" x 1-1/4"     | 20+27   | P5846-26  |
| 27e  | S6114-10B | Strike 4-7/8" x 1-1/4"     | 20+27   | P5846-10B |
| 28   | S6040     | Battery Pack Assembly      |         |           |



# IMPORTANT STARTUP PROCEDURE

## First Time Start Up

1. Unpack the lock from its factory packaging. With batteries disconnected, hold down any number key for 10 seconds and release.
2. Connect batteries and--within 3 seconds--press and hold  button. After hearing 6 beeps, release the  button. Wait 5 seconds for lock to re-lock (listen for 1 beep and red LED). The lock is now ready to accept programming.

**Important Notes:** Failure to follow this exact procedure can result in erratic lock behavior. When entering any programming key sequence, *do not pause more than 5 seconds between any key presses*--otherwise you must start again. **In addition, no other programming commands will be accepted until the Factory Master Code has been changed** (see User Guide OI209A to change the factory Master Code). When the factory Master Code has been changed, you can then enter new manager/user codes and program other functions.

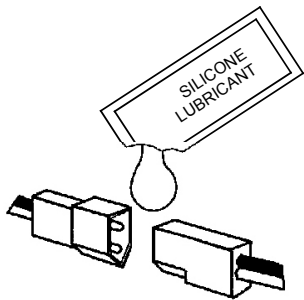

# IMPORTANT

Seal all connectors with Dielectric Grease (part MX959) or Silicone Lubricant (supplied)

© ALARM LOCK 2009



**ALARM LOCK**

W11822A 8/09



**ALARM LOCK**

345 Bayview Avenue  
Amityville, New York 11701  
For Sales and Repairs 1-800-ALA-LOCK  
For Technical Service 1-800-645-9440

(Note: Technical Service is for alarm professionals only)  
Publicly traded on NASDAQ Symbol: NSSC

# CORRECT WAY TO REMOVE INSIDE HOUSING FROM SPINDLE

© ALARM LOCK 2010

WI1871 5/10



Use key to depress the lever catch pin, then remove the inside handle.



Do NOT insert a screwdriver or other tool into the spindle to release the catch pin, as the catch spring is easily damaged.

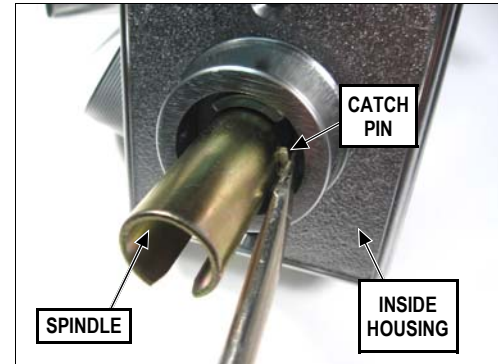

Press the catch pin as shown, then pull the inside housing off spindle.